

*** iPad Holder Attachment**

Attach connector piece to iPad holder. Then connect assembled iPad holder with connector to vertical extrusion.

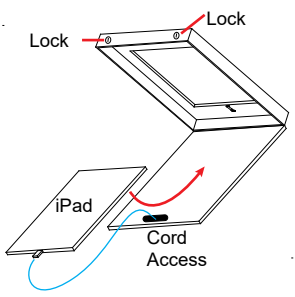
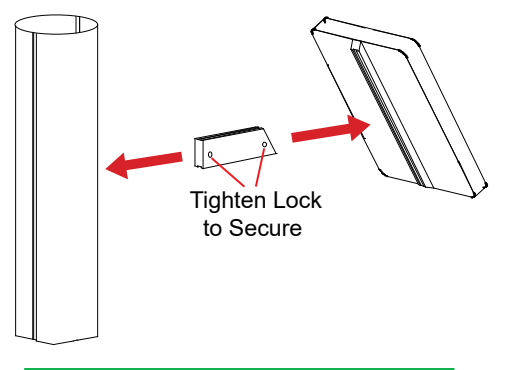

*** A10 Clamp**

Tighten set screw to secure A10 to Post.

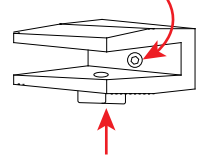

Tighten knob to secure graphic to A10 Clamp.

*** Literature Pocket Attachment**

Slide connector into groove of extrusion; secure with setscrew

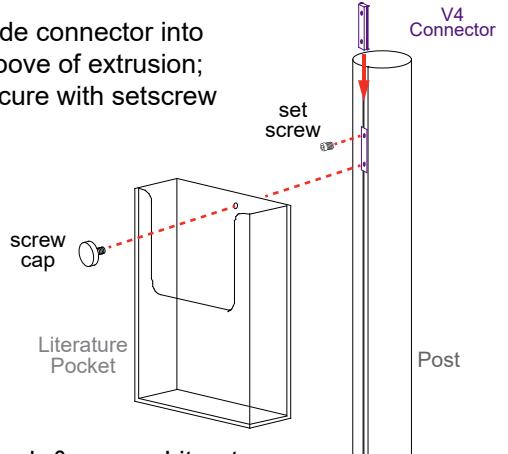

Attach & secure Literature Pocket using stand-off cap

*** Bracket Attachment**

Slide connectors into groove of extrusion; secure with setscrews.

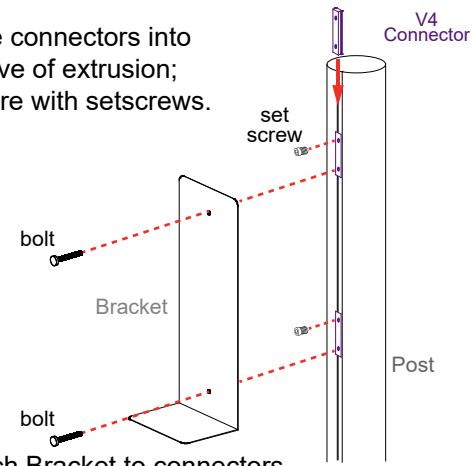

Attach Bracket to connectors using bolts.

Steps:

- 1) Connect Base Plate to bottom of post, using bolt.
- 2) Attach Graphic to top of post, using A10 clamp. See **A10 Clamp** detail.
- 3) Connect iPad Holder to post. See **iPad Holder Attachment** detail.
- 4) Attach Sanitizer Mount to post. See **Bracket Attachment** detail.
- 5) Connect Literature Trays. See **Literature Pocket Attachment** detail.

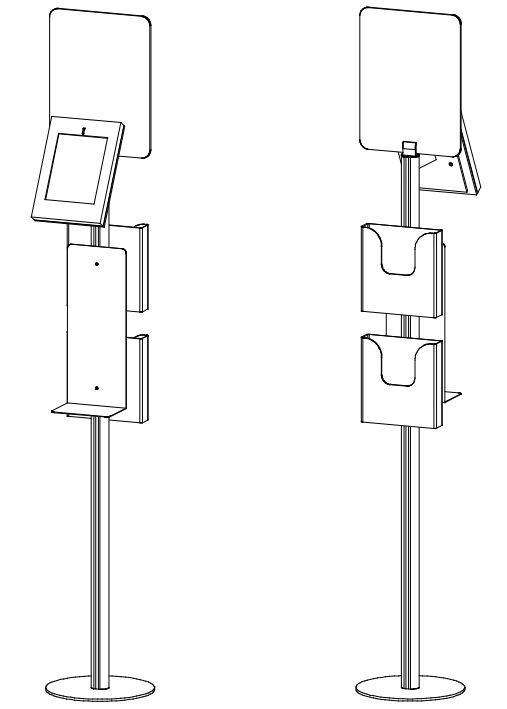
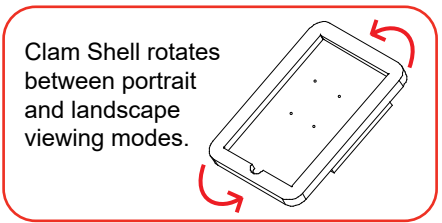
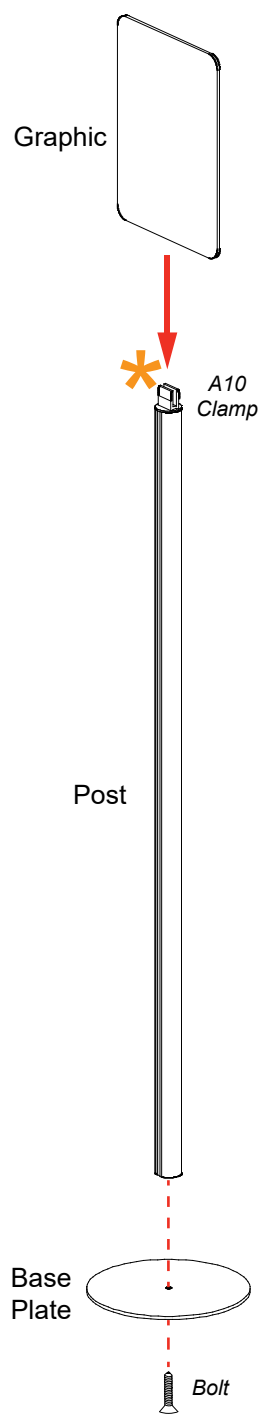

FRONT VIEW

BACK VIEW

Completed Assembly

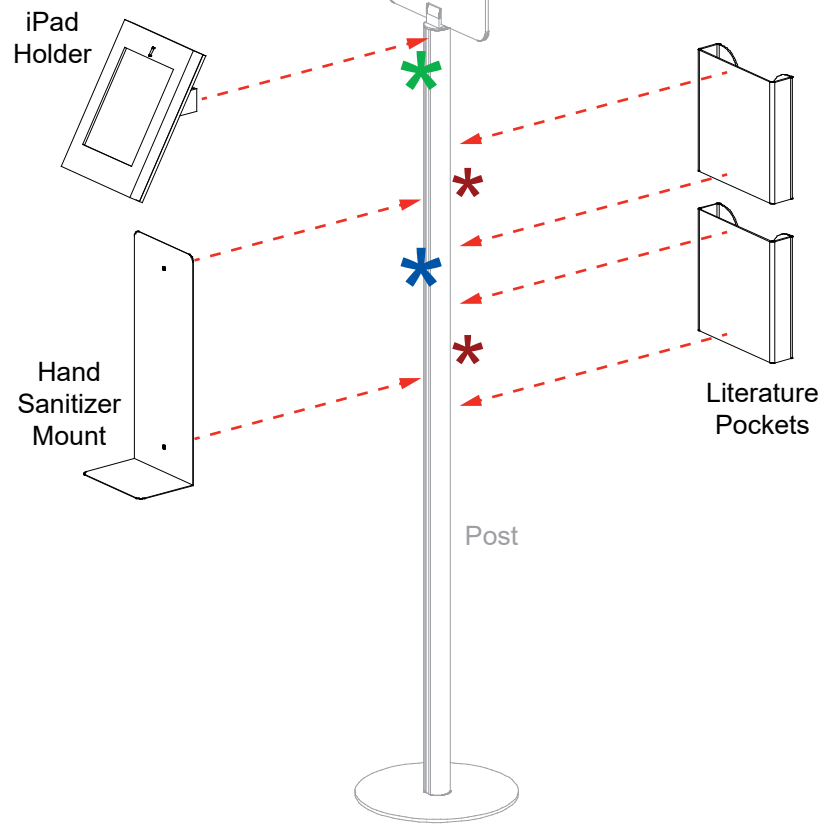

General Setup Instructions

- Read entire setup instruction manual prior to unpacking parts and pieces.
- The setup instructions are created specifically for this configuration.
- Setup instructions are laid out sequentially in steps, including exploded views with detailed explanation for assembly.

Cleaning & Packing

- For Cleaning Metal, Plex, & Laminate Parts: Use a **MILD NON-ABRASIVE** cleanser and soft cloth/paper towel to clean all surfaces.
- Keep exhibit components away from heat and prolonged sun exposure. **Heat and UV exposure will warp and fade components.**
- Retain all provided Packing Materials. All provided packing materials are for ease of repacking & component protection.

Disassembly

- For loss prevention, tighten all set screws and locks during disassembly.

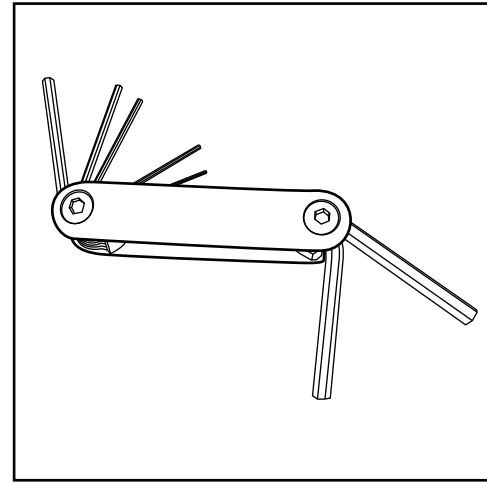

Hex Tool - Essential for Assembly

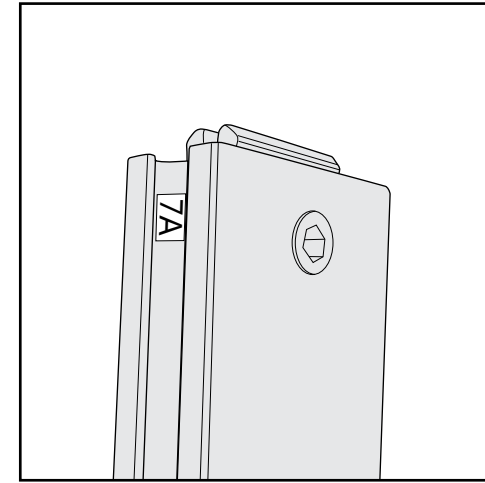

Part Identification - Numbering



Spline Connection



Base Plate & Extrusion Connection



Extrusion & Lock Connection



Engaged Lock



WARNING



DO NOT USE POWER TOOLS

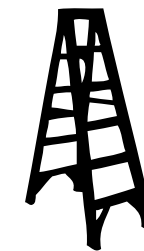

LADDERS OR LIFTS
MAY BE REQUIRED



ALL CONNECTIONS MUST
BE TIGHTLY SECURED